

SECTION 5

FITTINGS & HARDWARE

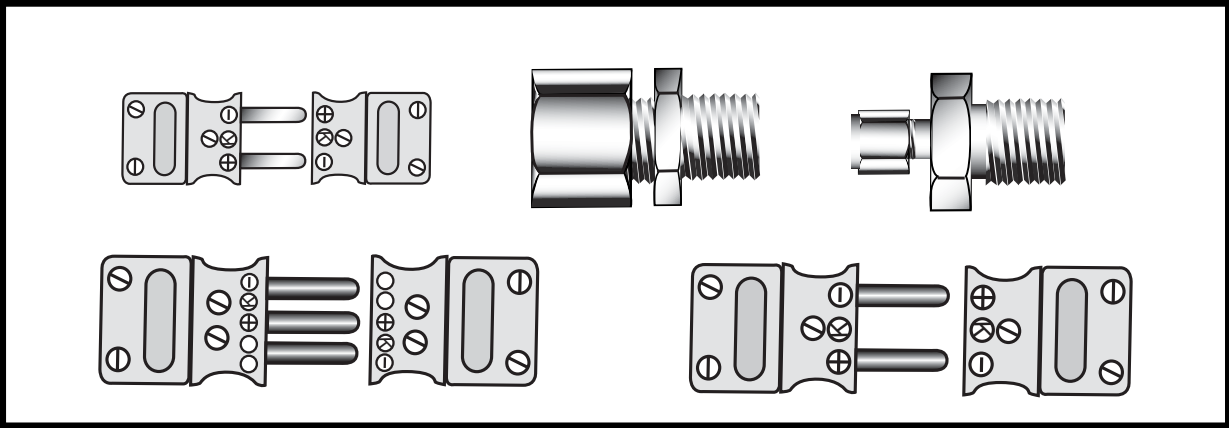

FITTINGS & HARDWARE INDEX-SECTION 5

Compression Fittings-Carbon Steel and Stainless Steel.....	72
Cord Grip Connectors.....	72
Thermocouple Connectors- Standard and Miniature.....	73-74

FITTINGS & HARDWARE



Compression Fittings

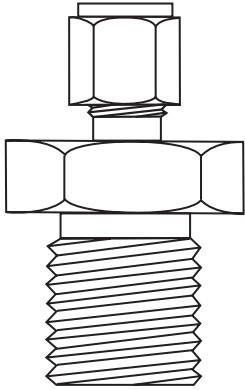

BRASS	CARBON STEEL	STAINLESS STEEL	DESCRIPTION
BA11	CA11	SA11	1/8" NPT X 1/16" TUBE DIA
BA12	CA12	SA12	1/8" NPT X 1/8" TUBE DIA
BA13	CA13	SA13	1/8" NPT X 3/16" TUBE DIA
BA14	CA14	SA14	1/8" NPT X 1/4" TUBE DIA
BA21	CA21	SA21	1/4" NPT X 1/16" TUBE DIA
BA22	CA22	SA22	1/4" NPT X 1/8" TUBE DIA
BA23	CA23	SA23	1/4" NPT X 3/16" TUBE DIA
BA24	CA24	SA24	1/4" NPT X 1/4" TUBE DIA
BA25	CA25	SA25	1/4" NPT X 5/16" TUBE DIA
BA26	CA26	SA26	1/4" NPT X 3/8" TUBE DIA
BA42	CA42	SA42	1/2" NPT X 1/8" TUBE DIA
BA43	CA43	SA43	1/2" NPT X 3/16" TUBE DIA
BA44	CA44	SA44	1/2" NPT X 1/4" TUBE DIA
BA45	CA45	SA45	1/2" NPT X 5/16" TUBE DIA
BA46	CA46	SA46	1/2" NPT X 3/8" TUBE DIA
BA48	CA48	SA48	1/2" NPT X 1/2" TUBE DIA

**Standard fittings are supplied with metallic ferrules Teflon ferrules are. To specify Teflon ferrule add letter designation "T" to basic part number.
Fittings are available in other materials. Consult TMS for availability.

Cord Grip Connectors

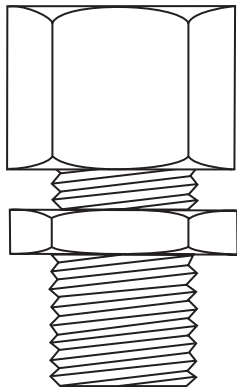

PART NO	CABLE/WIRE DIA.	THREAD SIZE
G3	.125 TO .250	1/2" NPT
G4	.250 TO .375	1/2" NPT
G5	.125 TO .250	3/4" NPT
G6	.250 TO .375	3/4" NPT

FITTINGS & HARDWARE

CONNECTORS

STANDARD AND MINIATURE CONNECTORS - Standard connectors are available in thermocouple calibrations as well as uncompensated (copper) alloys. These connectors are ANSI color coded and are rated to 350 Deg. F. (400 Deg. F max.). Plugs are available in solid pin and hollow pin constructions.

HIGH TEMPERATURE CONNECTORS - High temperature connectors are available in thermocouple calibrations as well as uncompensated (copper) alloys. These connectors are ANSI color coded and are rated to 500 Deg. F. (550 Deg. F max.) Ultra High Temperature connectors are also available but are not shown. Ultra High Temperature connectors are rated 800 Deg. F. continuous service or 1000 Deg. F. for intermittent service. Consult TMS for Ultra High Temperature Connectors.

Standard Connectors

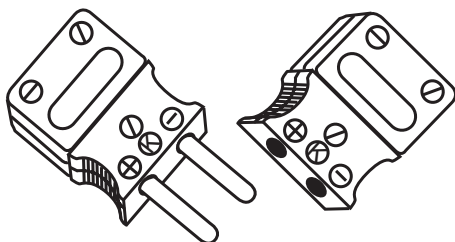

SOLID PIN PLUG	HOLLOW PIN PLUG	JACK	ANSI COLOR CODE	ANSI CALIBRATION
MP1J	MP4J	FJ1J	ORANGE	J
MP1K	MP4K	FJ1K	YELLOW	K
MP1T	MP4T	FJ1T	BLUE	T
MP1R	MP4R	FJ1R	GREEN	R OR S
MP1E	MP4E	FJ1E	PURPLE	E
MP1N	MP4N	FJ1N	ORANGE	N
MP1U	MP4U	FJ1U	WHITE	U

High Temperature Connectors

SOLID PIN PLUG	HOLLOW PIN PLUG	JACK	ANSI COLOR CODE	ANSI CALIBRATION
MP3J	MP4J	FJ2J	HIGH TEMPERATURE CONNECTORS ARE AVAILABLE IN BROWN ONLY.	J
MP3K	MP4K	FJ2K		K
MP3T	MP4T	FJ2T		T
MP3R	MP4R	FJ2R		R OR S
MP3E	MP4E	FJ2E		E
MP3N	MP4N	FJ2N		N
MP3U	MP4U	FJ2U		U

FITTINGS & HARDWARE

TMS

Standard 3-Pin Connectors

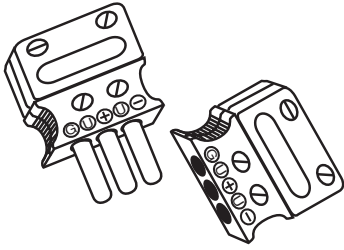

SOLID PIN PLUG	2 HOLLOW 1 SOLID PIN	JACK	ANSI COLOR CODE	ANSI CALIBRATION
MP5J	MP6J	FJ3J	ORANGE	J
MP5K	MP6K	FJ3K	YELLOW	K
MP5T	MP6T	FJ3T	BLUE	T
MP5R	MP6R	FJ3R	GREEN	R OR S
MP5E	MP6E	FJ3E	PURPLE	E
MP5N	MP6N	FJ3N	ORANGE	N
MP5U	MP6U	FJ3U	WHITE	U

Miniature 2-Pin Connectors

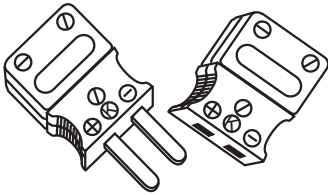

2 PIN PLUG	2 PIN JACK	HIGH TEMP 2 PIN PLUG	HIGH TEMP 2 PIN JACK	ANSI COLOR CODE	ANSI CALIBRATION
MP7J	FJ4J	MP8J	FJ5J	ORANGE	J
MP7K	FJ4K	MP8K	FJ5K	YELLOW	K
MP7T	FJ4T	MP8T	FJ5T	BLUE	T
MP7R	FJ4R	MP8R	FJ5R	GREEN	R OR S
MP7E	FJ4E	MP8E	FJ5E	PURPLE	E
MP7N	FJ4N	MP8N	FJ5N	ORANGE	N
MP7U	FJ4U	MP8U	FJ5U	WHITE	U

Miniature 3-Pin Connectors

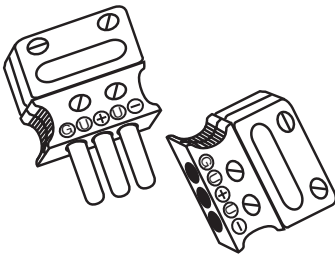

3 PIN PLUG	2 PIN JACK	HIGH TEMP 3 PIN PLUG	HIGH TEMP 3 PIN JACK	ANSI COLOR CODE	ANSI CALIBRATION
MP9J	FJ6J	MP10J	FJ7J	ORANGE	J
MP9K	FJ6K	MP10K	FJ7K	YELLOW	K
MP9T	FJ6T	MP10T	FJ7T	BLUE	T
MP9R	FJ6R	MP10R	FJ7R	GREEN	R OR S
MP9E	FJ6E	MP10E	FJ7E	PURPLE	E
MP9N	FJ6N	MP10N	FJ7N	ORANGE	N
MP9U	FJ6U	MP10U	FJ7U	WHITE	U